



International Patent Public No.:  
WO 2006/007772  
US Patent No.: 7549446  
India Patent No.: 232582  
Russia Patent No.:2349819  
South Korea Patent No.:10-0914137  
Mexico Patent No.: 268581  
Australia Patent No.: 2005263257  
Phillipine Patent No.: 1-2006-502553  
Taiwan Patent No.:M287896

## Multi-functional Flow Control Valve for Water Treatment Systems

63504P, 63604P (Old Model No.: F63P1,F63P3)  
73504P, 73604P (Old Model No.: F68P1,F68P3)  
63502P, 63602P (Old Model No.: F65P1,F65P3)  
73502P, 73602P (Old Model No.: F69P1,F69P3)  
53504P (Old Model No.: F67P1)  
53502P (Old Model No.: F71P1)

## User Manual





Please read this manual in details  
before using this valve and keep it properly  
in order to consult in the future

0WRX.466.561

## MODEL:F63P/F68P/F65P/F69P/F67P/F71P

Before the valve put into use, please fill in the below content so as to help us to refer in the future.

### **The Program Type Setting (Operation by professional)**

When all symbols light on, press and hold  and  buttons for 5 seconds to enter the menu of valve model selection. **Please set the program type in accordance with the product type.** (Time clock type by days or meter type. For example, F63P1 should be set as F63P1; F63P3 should be set as F63P3. It should not be set to other type.)

### **Softener System Configuration**

Tank Size: Dia. \_\_\_\_\_ mm; Height \_\_\_\_\_ mm;  
Resin Volume \_\_\_\_\_ L; Brine Tank Capacity \_\_\_\_\_ L;  
Hardness of Raw Water \_\_\_\_\_ mmol/L;  
Pressure of Inlet Water \_\_\_\_\_ MPa;  
Control Valve Model \_\_\_\_\_; Number \_\_\_\_\_;  
The Specification of Drain Line Flow Control \_\_\_\_\_;  
Injector No. \_\_\_\_\_;  
Water Source: Ground-water  Filtered Ground-water  Tap Water  Other \_\_\_\_\_.

### **Filter System Configuration**

Tank Size: Dia. \_\_\_\_\_ mm, Height \_\_\_\_\_ mm;  
Filter Material \_\_\_\_\_ Kg; Filter Material Height \_\_\_\_\_ mm;  
Turbidity of Inlet Water \_\_\_\_\_ FTU;  
Pressure of Inlet Water \_\_\_\_\_ MPa;  
Control Valve Model \_\_\_\_\_; Number \_\_\_\_\_;  
Water Source: Ground-water  Filtered Ground-water  Tap Water   
Other \_\_\_\_\_.

## MODEL:F63P/F68P/F65P/F69P/F67P/F71P

### Parameter Setting

Parameter	Unit	Factory Default	Actual Value
Time of Day	H:m	Random	
Control Mode A-01/02/ (P3 meter type available)	/	A-01	
Unit Mode HU-1/2 (P3 meter type available)	/	HU-1	
Water Treatment Capacity (P3 meter type available)	m <sup>3</sup>	10	
Service Days (Time clock type, by days)	D.	03	
Regeneration Time	/	02:00	
Backwash Interval Times (F68P/F69P available)	/	F-00	
Rinsing Frequency (F67P/F71P available)	/	F-00	
Backwash Time	min.	10	
Brine & Slow Rinse Time	min.	60	
Brine Refill Time	min.	05	
Fast Rinse Time	min.	10	
Maximum Interval Regeneration Days (P3 meter type available)	D.	30	
<b>Output Mode b-01(02)</b>	/	b-01	

●If there is no special requirement when product purchase, for F63P/F68P, we choose 6309 (old) injector and 8468007 drain line flow control for the standard configuration; if need new injector ,we choose 6809 (new) injector and without drain line flow control for the standard configuration. For F65P/F69P, we choose 6305 (old) injector and 8468005 drain line flow control for the standard configuration; if need new injector, we choose 6804 (new) injector and 8468061 drain line flow control for the standard configuration.

## Catalogue

Notice.....	4
1. Product Overview.....	5
1.1. Main Application & Applicability.....	5
1.2. Product Characteristics.....	5
1.3. Service Condition.....	7
1.4. Product Structure and Technical Parameters.....	8
1.5. Installation.....	10
2. Basic Setting & Usage.....	13
2.1. The Function of PC Board.....	13
2.2. Basic Setting & Usage.....	14
3. Applications.....	17
3.1. Softener and Filter Flow Chart.....	17
3.2. The Function and Connection of PC Board.....	19
A. Signal Output Connector.....	20
B. Interlock.....	23
C. Interlock System.....	24
3.3. System Configuration and Flow Rate Curve.....	24
3.4. Parameter Settlement.....	29
3.5. Parameter Enquiry and Setting.....	31
3.6. Trial Running.....	34
3.7. Trouble-Shooting.....	35
3.8. Assembly & Parts.....	39
4. Warranty Card.....	54

## Notice

- To ensure normal operation of the valve, please consult with professional installation or repairing personnel before use it.
- If there are any of pipeline engineering and electric works, there must be finished by professional at the time of installation.
- Do not use the control valve with the water that is unsafe or unknown quality.
- Depending on the changing of working environment and water requirement, each parameter of softener should be adjusted accordingly.
- When the water treatment capacity is too low, please check the resin. If the reason is short of resin, please add; if the resin is turn to reddish, brown or broken, please replace.
- Test water periodically to verify that system is performing satisfactorily.
- Sodium used in the water softening process should be considered as part of your overall dietary salt intake. Contact your doctor if you are on a low sodium diet.
- Ensure that there is solid salt all the time in the brine tank in the course of using, when this valve is used for softening. The brine tank should be added crystalline coarse salt only, at least 99.5% pure, forbidding use the small salt.
- Do not put the valve near heat sources, or surroundings with high humidity, corrosive, intense magnetic field or intense vibrations environment. And do not leave it outside.
- Forbidden to carry the injector body. Avoid to use injector body as support to carry the system.
- Forbidden to use the brine tube or other connectors as support to carry the system.
- Please use this product under the water temperature between 5 ~ 50°C, water pressure 0.15 ~ 0.6MPa. Failure to use this product under such conditions voids the warranty.
- If the water pressure exceeds 0.6MPa, a pressure reducing valve must be installed before the water inlet; While, if the water pressure is under 0.15MPa, a booster pump must be installed before the water inlet.
- PPR pipes, corrugated pipes, or UPVC pipes are recommended for pipe installation and aluminum-plastic pipes should be avoided.
- Do not let children touch or play, because careless operations may cause the procedure changed.
- When the attached cables of this product and transformer are damaged, they must be changed to the one that is from our factory.

## 1. Product Overview

### 1.1. Main Application & Applicability

Used for intelligent filtering and softening in the water treatment systems

Be suitable for

- Residential softening system
- Residential filtration system
- Boiler softening water system
- RO pretreatment softening system, etc.

### 1.2. Product Characteristics

#### ● Simple structure and reliable sealing

It adopts hermetic head faces with high degree pottery and corrosion resistance for opening and closing. It combines with Service, Backwash, Brine & Slow Rinse, Brine Refill and Fast Rinse for softener or Service, Backwash and Fast Rinse for filter.

#### ● No water pass the valve in regeneration in single tank type.

#### ● Manual function

Realize regeneration immediately by pressing “” at any time.



#### ● Long outage indicator

If outage overrides 3 days, the time of day indicator “12:12” will flash to remind the people to reset new time of day. The other set parameters do not need to reset. The process will continue to work after power on.

#### ● The valve will automatically rotate for dozens of seconds after it is electrified.

After the valve is electrified, it will automatically rotate for dozens of seconds to turn back to the position when the electricity is cut off.



#### ● Buttons lock

No operations to buttons on the controller within 1 minute, button lock indicator lights on which represent buttons are locked. Before operation, press and hold the  and  buttons for 5 seconds to unlock. This function can avoid incorrect operation.

#### ● Interval backwash times (Suitable for F68P/F69P)

It could set up interval backwash times for F68P/F69P up-flow regeneration valve which means several times of services but one time of backwash. The setting of interval backwash time depends on the local water turbidity. (The lower the turbidity is, the longer of the interval backwash time can be set)

#### ● It can choose time clock type or meter type by program selection

When all symbols light on, press and hold  and  buttons for 5 seconds to enter the menu of valve model selection. Please set the program type in accordance with the product type. (Time clock type by days or meter type) (Note: The meter type product has one flow meter and probe wire, but the time clock type doesn't have).

## MODEL:F63P/F68P/F65P/F69P/F67P/F71P

### ● Two meter types can be selected ( Suitable for F63P3, F65P3, F68P3, F69P3)

Model	Name	Instruction
A-01	Meter Delayed	It will not regenerate although the available volume of treated water drops to zero (0). Regeneration will start until at the regeneration time.
A-02	Meter Immediate	Regenerate immediately when the available volume of treated water drops to zero(0).

### ● Interlock function

It has a function of interlock to realize only one valve in regeneration but the other valves are in service while several valves parallel in system. In multi-steps treatment systems such as RO pre-treatment, when several valves are in series, there is only one valve in regeneration or washing to ensure pass water all the time while different valves in regeneration or washing. (Application refer to Figure 3-9)

### ● Signal Output (F63P as example)

There is a signal output connector on main control board. It is for controlling external wiring (Refer to Figure from Figure3-1 to Figure 3-8).

There are two kinds of output modes:

b-01 Mode: Turn on start of regeneration and shut off at the end of regeneration; b-02 Mode: Signal available only intervals of regeneration cycles and in service.

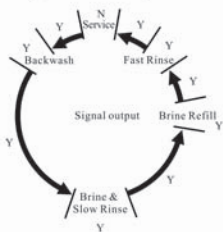

b-01

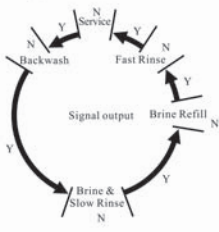

b-02

### ● Maximum interval regeneration days

Under the situation of service reaching the setting days and the volume not yet, it could enter into regeneration process forcibly when current time is the same as regeneration time.

### ● All parameters can be modified

According to the water quality and usage, the parameters in the process can be adjusted.

MODEL:F63P/F68P/F65P/F69P/F67P/F71P

**1.3. Service Condition**

Runxin Valve should be used under the below conditions:

Items		Requirement
Working Conditions	Water pressure	0.15MPa ~ 0.6MPa
	Water temperature	5℃ ~ 50℃
Working Environment	Environment temperature	5℃ ~ 50℃
	Relative humidity	≤95% ( 25℃ )
	Electrical facility	AC100 ~ 240V/50 ~ 60Hz
Inlet Water Quality for Softener	Water turbidity	Down-flow regeneration < 5FTU; Up-flow regeneration < 2FTU
	Water hardness	First Grade Na <sup>+</sup> < 6.5mmol/L; Second Grade Na <sup>+</sup> < 10mmol/L
	Free chlorine	< 0.1mg/L
	Iron <sup>2+</sup>	< 0.3mg/L
	CODMn	< 2mg/L ( O <sub>2</sub> )
Inlet Water Quality for Filter	Water turbidity	< 20FTU

In the above table, First Grade Na<sup>+</sup> represents First Grade Na<sup>+</sup> Exchanger. Second Grade Na<sup>+</sup> represents Second Grade Na<sup>+</sup> Exchanger.

● When the water turbidity exceeds the conditions, a filter should be installed on the inlet of control valve.

● When the water hardness exceeds the conditions, the outlet water hardness will hardly reach the requirement of boiler feed water (0.03 mmol/L). It is suggested to adopt second grade softener.



## MODEL:F63P/F68P/F65P/F69P/F67P/F71P

### 1.4. Product Structure and Technical Parameters

The appearance is just for reference. It is subjected to the real product.

#### A. F63P1/F63P3/F68P1/F68P3

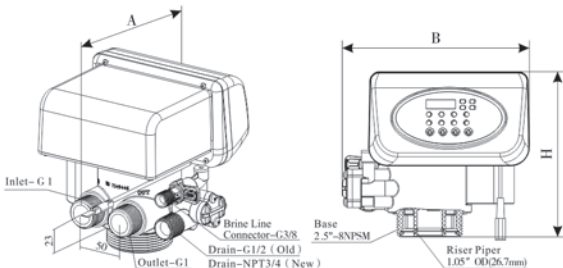

Model	A (mm) max	B (mm) max	H (mm) max	Flow Rate m <sup>3</sup> /h @0.3MPa	Regeneration Mode
F63P1/F63P3	282	198	177	4.0	Down-flow
F68P1/F68P3	282	198	176.5	4.0	Up-flow

Note:

1. OD—Outer Diameter, 1.05OD=26.7mm
2. Transformer Output: DC12V/1.5A

#### B. F65P1/F65P3/F69P1/F69P3

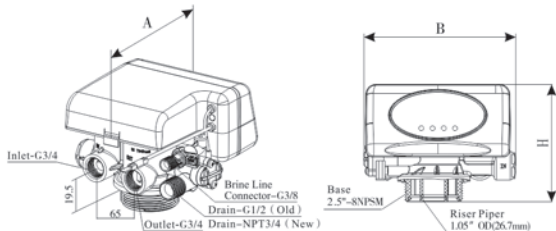

**MODEL:F63P/F68P/F65P/F69P/F67P/F71P**

Model	A (mm) max	B (mm) max	H (mm) max	Flow Rate m <sup>3</sup> /h @0.3MPa	Regeneration Mode
F65P1/F65P3	187.3	187.8	142.8	2.0	Down-flow
F69P1/F69P3	196.4	187.8	152.8	2.0	Up-flow

**C. F71P1**

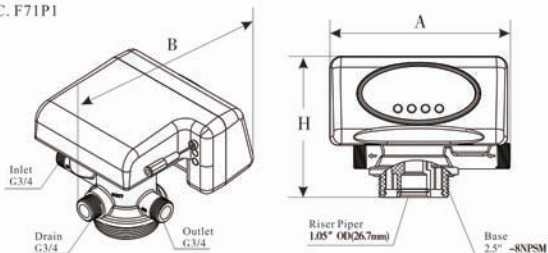

Model	A(mm) max	B(mm) max	H(mm) max	Control Valve Transformer Output	Flow Rate m <sup>3</sup> /h @0.3MPa
F71P1 (53502P)	180	182	143	DC12V, 1.5A	2.0

**D. F67P1**

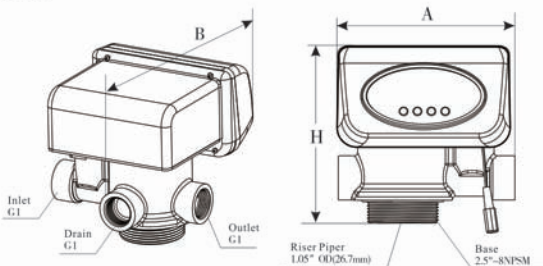

## MODEL:F63P/F68P/F65P/F69P/F67P/F71P

Model	A(mm) max	B(mm) max	H(mm) max	Control Valve Transformer Output	Flow Rate m <sup>3</sup> /h @0.3MPa
F67P1 (53504P)	180	194	178.5	DC12V, 1.5A	4.0

### 1.5. Installation

#### A. Installation notice

Before installation, read all those instructions completely. Then obtain all materials and tools needed for installation.

The installation of product, pipes and circuits should be accomplished by professional to ensure the product can operate normally.

Perform installation according to relevant pipeline regulations and the specifications of Water Inlet, Water Outlet, Drain Outlet, Brine Line Connector.

#### B. Device location

- ①The filter or softener should be located as close as to drain.
- ②Ensure the unit is installed in enough space for operating and maintenance.
- ③Brine tank needs to be close to softener.
- ④The unit should be kept away the heater, and not be exposed outdoor. Sunshine or rain will cause the system damage.
- ⑤Avoid installing the system in circumstance of acid/alkaline, magnetic or strong vibration, because above factors will cause the system disorder.
- ⑥Do not install the filter or softener, drain pipeline or overflow pipe in circumstance where temperature may drop below 5℃, or above 50℃.
- ⑦Install the system in the place where with the minimum loss in case of water leakage.

#### C. Pipeline installation (F63P3 as example)

##### ①Install control valve

a. As the Figure 1-1 shows, select the riser pipe with 26.7mm OD, glue the riser pipe to the bottom strainer and put it into the mineral tank, cut off the exceeding pipe out of tank top opening and make external rounding.

b. Fill the mineral to the tank, and the height is accordance with the design code.

c. Install the top strainer to the valve.

d. Through the top strainer, insert the riser pipe into control valve and screw tight control valve.

## MODEL:F63P/F68P/F65P/F69P/F67P/F71P

### Note:

- The length of riser pipe should be neither 2mm higher nor 5mm lower than tank top opening, and its top end should be rounded to avoid damaging of O-ring inside the valve.
- Avoid filling floccules substance together with resin to the resin tank.
- Avoid O-ring inside control valve falling out while rotating it on the tank.



Figure 1-1

### ② Install animated connector

As Figure 1-2 shows, put the sealing ring into nut of animated connector, and screw in water inlet.

### ③ Install flow meter

As Figure 1-2 shows, put the sealing ring into nut of flow meter, screw in water outlet; insert the probe wire into flow meter.

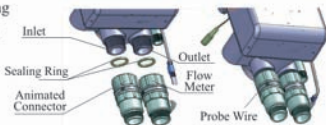

Figure 1-2

### ④ Pipeline connection

a. As Figure 1-3 shows, install a pressure gauge in water inlet.

b. Install valve A, valve B, valve C and valve D in the inlet, outlet and middle of the pipeline. The valve D is sampling valve. (Or adopt F70A/F70C bypass valve).

c. Install a check valve in water outlet.

d. Inlet pipeline should be in parallel with outlet pipeline. Support inlet and outlet pipeline with fixed holder.

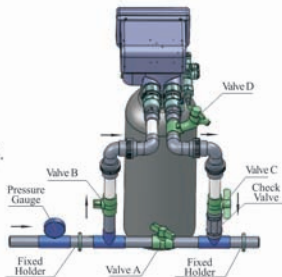

Figure 1-3

## MODEL:F63P/F68P/F65P/F69P/F67P/F71P

### Note:

● If the water outlet or water tank is installed higher than control valve or parallel interlock system with multi-outlets, a liquid level controller must be installed in brine tank or a check valve must be installed in the outlet. Or else, the water in water outlet or water tank will flow backwards into brine tank when backwash.

● If making a soldered copper installation, do all sweat soldering before connecting pipes to the valve. Torch heat will damage plastic parts.

● When turning threaded pipe fitting onto plastic fitting, do not use excessive force to make threads misaligned or broken valve.

### ⑤ Install drain pipeline

a. As the Figure 1-4 shows, slide the drain hose connector into drain outlet.

b. Insert drain line flow control into drain outlet

c. Screw drain hose connector into drain outlet, and lock it.

d. Locate the drain hose well as the Figure1-4 shows.

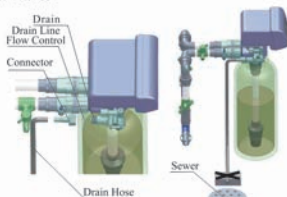

Figure 1-4

### Note:

● Control valve should be higher than drain outlet, and be better not far from the drain hose.

● Be sure not connect drain with sewer directly, and leave a certain space between them, avoid wastewater being absorbing to the water treatment equipment, such as showed in the Figure1-4.

### ⑥ Connect brine tube

a. As Figure1-5 shows, slide 3/8" brine tube hose connector over end of brine tube.

b. Insert tube bushing into the end of brine tube.

c. Insert the red brine line flow control into valve brine line connector (Note: cone side of control should face into valve)

d. Tighten nut onto brine line connector.

e. Connect the other end of brine tube with the brine tank. ( The liquid level controller and air-blocker should be installed in the brine tank.)

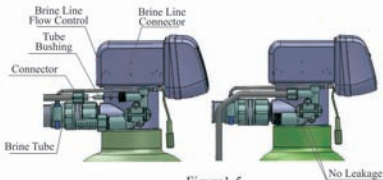
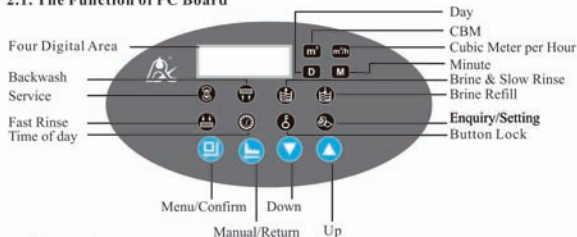

Figure1-5

**Note: The brine tube and drain pipeline should not be bended or plugged.**

## 2. Basic Setting & Usage

### 2.1. The Function of PC Board



#### A. ⌚ Time of day indicator

- ⌚ Lights on, display the time of day.
- "12:12" flashes, remind you to reset the time of day if electrical service interrupted 3 days more (If electrical service interrupted within 3 days, it doesn't need to reset the time.)

#### B. 🔒 Button lock indicator

- 🔒 Lights on, indicate the buttons are locked. At this moment, press any single button will not work (No operation in one minute, 🔒 will light on and lock the buttons.)
- Solution: Press and hold both ▲ and ▼ for 5 seconds until the 🔒 lights off.

#### C. ⌚ Program mode indicator

- ⌚ Lights on, enter program display mode. Use ▲ or ▼ to view all values.
- ⌚ Flashes, enter program set mode. Press ▲ or ▼ to adjust values.

#### D. ⌚ Menu/Confirm button



- In menu mode, press ⌚, ⌚ lights on, then enter program display mode to view all values.
- In program display mode, press ⌚, ⌚ flashes, enter program set mode, press ▲ or ▼ to adjust values.
- Press ⌚ after all program are set, and then the voice "Di" means all setting are successful and return program display mode.

#### E. ⌚ Manual/Return button



- Press ⌚ in any status, it can proceed to next step.(Example: After unlock the buttons, press ⌚ in service status, it will start regeneration cycles instantly if the outlet water is unqualified;

## MODEL:F63P/F68P/F65P/F69P/F67P/F71P



Press  while it is in backwash status, it will end backwash and go to brine & slow rinse at once.)

● Press  in program display mode, and it will return in service; Press  in program set mode, and it will return program display mode.

● Press  while adjusting the value, then it will return to program display mode directly without saving value.

F..Up  and Down 







● In program display mode, press  or  to view all values.

● In program set mode, press  or  to adjust values.

● Press and hold both  and  for 5 seconds to unlock the buttons.

### 2.2. Basic Setting & Usage

#### A. Parameter specification

Function	Indicator	Factory Default	Parameter Set Range	Instruction
Time of Day		Random	00:00 ~ 23:59	Set the time of day when use; ":" flashes.
Control Mode	A-01	A-01	A-01	Meter Delayed: Regenerate will not start although the available volume of treated water drops to zero (0). Regeneration will start until at the regeneration time.
			A-02	Meter Immediate: Regenerate immediately when the available volume of treated water drops to zero(0).
Unit Mode	HU-01	HU-01	1,2	1-m <sup>3</sup> ; 2-gal.
Service Days		1-03D	0 ~ 99Days	Only for Time Clock Type, regeneration by days.
Regeneration Time	02:00	02:00	00:00 ~ 23:59	Regeneration time; ":" lights on.
Interval Backwash Times	F-00	00	0 ~ 20	For example, F-01 indicate service 2 times, backwash 1 time. (Only for F68P, F69P)
Rinsing Frequency	F-00	00	0 ~ 20	For example, F-01 indicate rinse 2 times, service 1 time. (Only for F67P, F71P)
Water Treatment Capacity		10m <sup>3</sup>	0~99.99 m <sup>3</sup>	Water treatment capacity in one circle (m <sup>3</sup> )
Backwash Time		10min.	0 ~ 99	Backwash time(Minute)
Brine & Slow Rinse Time		60min.	0 ~ 99	Brine & Slow rinse time(Minute)
Brine Refill Time		5min.	0 ~ 99	Brine refill time(Minute)

**MODEL:F63P/F68P/F65P/F69P/F67P/F71P**

Fast Rinse Time	iii iii	10min.	0 ~ 99	Fast rinse time(Minute)
Maximum Interval Regeneration Days	H-30	30	0 ~ 40	Regenerate at the regeneration time even though the available volume of treated water does not drop to zero (0).
Output Control Mode	b-01	01	01 or 02	Mode 01: Signal turn on start of regeneration and shut off end of regeneration. (Connection refers to the Figure P6 ) Mode 02: Signal available only intervals of regeneration cycles and in service. (Connection refers to the Figure P6 )

**B. Process Display(Take F65P3, A-01 as sample)**



Figure A



Figure B



Figure C



Figure D



Figure E



Figure F

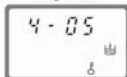

Figure G



Figure H

**Illustration:**

- In Service status, the figure shows A/B/C/D; In Backwash status, it shows figure E/C; In Brine& Slow Rinse status, it shows F/C; In Brine Refill status, it shows figure G/C; In Fast Rinse status, it shows figure H/C. In each status, every figure shows 15 seconds.
- Above displays are taking F65P3 A-01 mode for example. For the time clock type, it shows the rest days, such as 1-03D.
- The display screen will only show “-00-” when the electrical motor is running.
- The time of day figure “⊙” flashes continuously, such as “12:12” flashes, indicates long outage of power. It reminds to reset the time of day.
- The display will show the error code, such as “-E1-”when the system is in error.
- F63P/F65P/F68P/69P working process: Service→ Backwash→ Brine & Slow Rinse→ Brine Refill→ Fast Rinse→ Service.
- F67P/F71P working process: Service→ Backwash→ Fast Rinse→ Service.















### C. Usage

After being accomplished installation, parameter setting and trial running by professional, the valve can be put into use. In order to ensure that the quality of outlet water can reach the requirements, the user should complete the below works:













①Ensure that there is solid salt all the time in the brine tank in the course of use when this valve is used for softening. The brine tank should be added crystalline coarse salt only, at least 99.5% pure, forbidding use the small salt and iodized salt

②Test the hardness of outlet water and raw water at regular time. When the outlet water hardness is unqualified, please press the  and the valve will temporarily regenerate again ( It will not affect the original set operation cycle).

③When the feed water hardness changes a lot, you can adjust the water treatment capacity as follows:

Press and hold both  and  for 5 seconds to unlock the buttons. Press , and the  lights on, then press , the digital area shows the control mode. If it shows A-01 or A-02, press  continuously, the digital area will show the given water treatment capacity; Press  again,  and digital flash. Press  or  continuously, adjust the capacity value. Press  and hear a sound "Di", then finish the adjustment. Press  exit and turn back the service status.

For the estimation of water treatment capacity, you can refer to the professional application specification.

④For A-01 control mode (Delayed regeneration type), please pay attention to whether the time is current or not. If the time is not right, you can adjust as below: After unlocking the buttons, press , the  and  light on. Then press , the  and hour value flash. Press  or  continuously, adjust the hour value; Press  again,  and minute value flash. Press  or  continuously, adjust the minute value; Press  and hear a sound "Di", then finish the adjustment. Press  exit and turn back to the service status.

The regeneration parameters have been set when control valve left the factory. Generally, it does not need to reset. If you want to enquiry and modify the setting, you can refer to the professional application specifications.

**3.1.Softener and Filter Flow Chart**

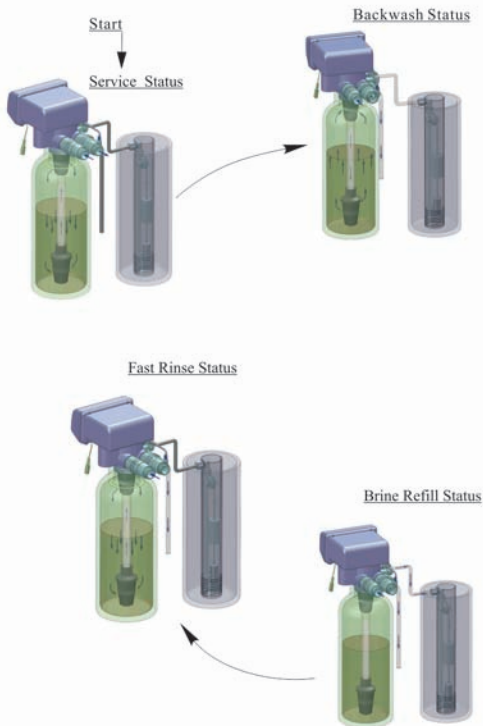

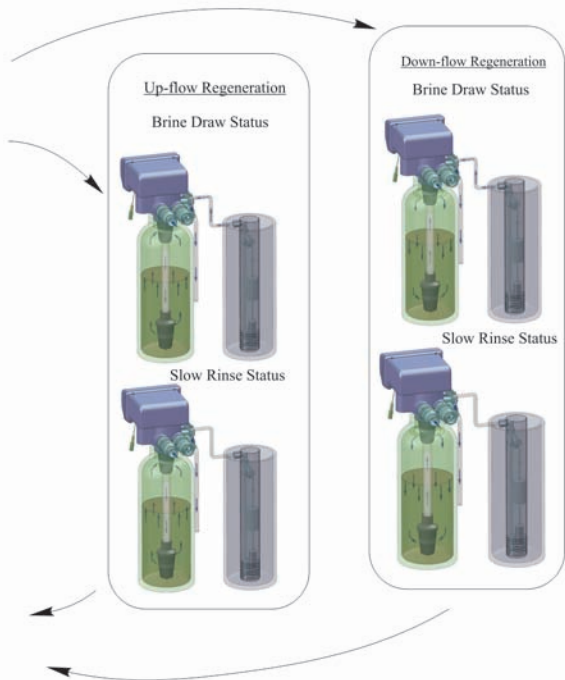

## MODEL:F63P/F68P/F65P/F69P/F67P/F71P

### B. Filter

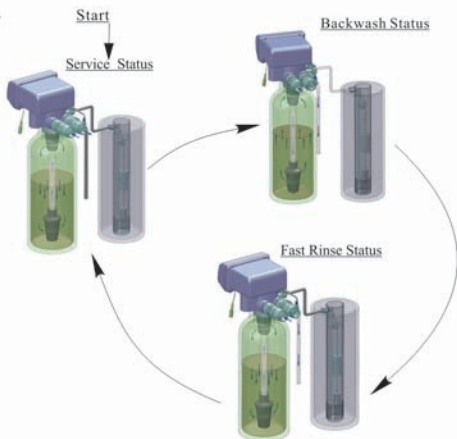

### 3.2. The Function and Connection of PC Board

Open the front cover of control valve, you will see the main control board and connectors as below:



## MODEL:F63P/F68P/F65P/F69P/F67P/F71P

The main functions on main control board:

Function	Application	Explanation
Signal output connector b-01	Outlet solenoid valve	Used in strict requirements regarding no hard water flowing from outlet or control the liquid level in water tank.
	Inlet pump	Increase pressure for regeneration or washing. Use the liquid level controller to control inlet pump to ensure there is water in tank.
Signal output connector b-02	Inlet solenoid valve or inlet pump	When inlet pressure is high, it needs to close water inlet to protect motor when valve is rotating.
Interlock connector	To ensure only one control valve in regeneration or washing in system.	Used in RO Pre-treatment, water supply together but regeneration in turn. Second grade ion exchange equipment, etc.

### A. Signal Output Connector

#### 1) Control Outlet Solenoid Valve (Set b-01)

##### ① Solenoid Valve on Outlet Controls Water Level in Brine Tank.

**Instruction:** If system requires no hard water to flowing from outlet in regeneration cycle ( Mainly for no hard water flow out when valve is switching or valve in backwash or brine drawing status), a solenoid valve could be installed on outlet, the wiring refers to Figure 3-1.

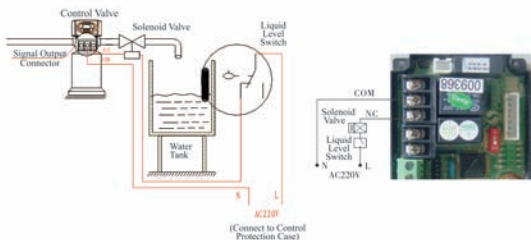

Figure 3-1 Wiring of Solenoid Valve on Outlet

### Function:

When valve is in service status, if soft water tank is short of water, solenoid valve will open to supply soft water, but if water tank has enough water, solenoid valve will close, so no soft water will be supplied into soft water tank.

## MODEL:F63P/F68P/F65P/F69P/F67P/F71P

When the valve is in backwash or other regeneration status, there is no signal output. So, solenoid valve will close, and no raw water flows into soft water tank.

### ②Control Inlet Solenoid Valve (Set b-02)

**Instruction:** When inlet pressure exceeds 0.6MPa, install a solenoid valve on inlet. Control mode is b-02. Pressure is relieved when valve switching, the wiring refers to Figure 3-2. As Figure 3-3 shows, it also can use the pressure relief connector to work.

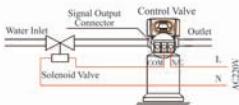

Figure 3-2 Wiring of Solenoid Valve on Inlet

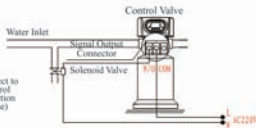

Figure 3-3 Wiring of Pressure Relief Port

### Function:

When inlet pressure is high, install a solenoid valve on inlet to ensure valve switching properly. When valve is exactly in status of Service, Backwash, Brine & Slow Rinse, Brine Refill and Fast Rinse, solenoid valve is open. When valve is switching, solenoid valve is closed, no water flows into valve to ensure valve switching properly. It could prevent the problem of mixing water and water hammer.

Use interlock cable to realize valves in parallel and series in same system which is suited for RO pretreatment system or second grade Na<sup>+</sup> system. The Wiring refers to Figure 3-4:

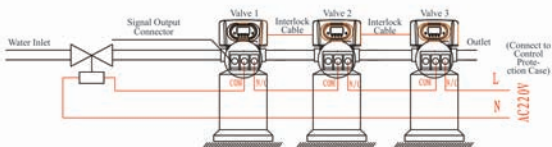

Figure 3-4 Wiring of Solenoid Valve in Inlet

### 2) Liquid Level Controller Controls Inlet Pump (Two-phase motor) (Set b-01)

**Instruction:** For the system using well or middle-tank supplying water, switch of liquid level controller and valve together control pump opening or closing. The wiring refers to Figure 3-5:

## MODEL:F63P/F68P/F65P/F69P/F67P/F71P

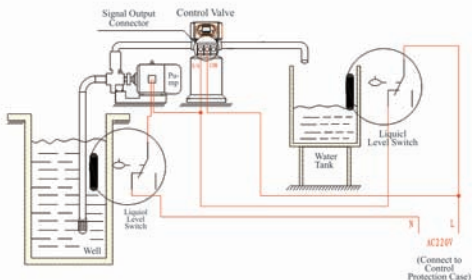

Figure 3-5 Wiring of Liquid Level Controller Controlling Inlet Pump

### Function:

When valve is in service status, if water tank is short of water, pump starts working; if not, the switch of liquid level controller is closed, so pump does not work.

When valve is in backwash or other regeneration status, no matter what is water condition in water tank, open the pump to make sure there is water on inlet. As there is no water flows out of outlet in regeneration cycle, it ensures no water fill into brine tank. A liquid level controller at the top opening of well or in middle water tank in RO system can protect pump from working without water in case of out of raw water.

### 3) Liquid Level Controller in Water Tank Controls Inlet pump (Three-phase) (Set b-01)

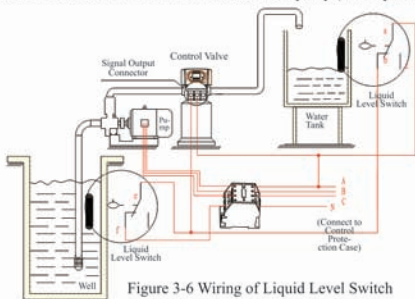

Figure 3-6 Wiring of Liquid Level Switch in Water Tank Controls Inlet Pump

4) Control Inlet Booster Pump( Set b-01 or b-02)

**Instruction:** If inlet water pressure is less than 0.1MPa, which makes backwash or brine difficult, a booster pump is suggested to be installed on inlet. Control mode set to b-01. When system in regeneration cycle, booster pump is open, the wiring refers to Figure 3-7. If the booster pump current is bigger than 5A, the system needs to install a contactor, the wiring refers to Figure 3-8.

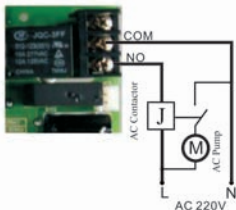
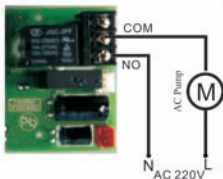

Figure 3-7 Wiring of Booster Pump on Inlet

Figure 3-8 Wiring of Booster Pump on Inlet

**B. Interlock**

**Instruction:**

In the parallel water treatment system, it ensures only one valve in regeneration or washing status and (n-1) valves in service, that is, realizing the function of supplying water simultaneously and regenerating individually.

In the series water treatment system(Second grade Na<sup>+</sup> Exchanger or RO pre-treatment system), it ensures only one valve in regeneration or washing status and there is/are water (s) in service. The wiring refers to Figure 3-9.



Figure 3-9 Network System Wiring with Interlock Cable

**Note:**

Use interlock cable to connect the black socket of one valve with the blue socket of another valve in series.

One system with several valves, if interlock cable is disconnected, the system is divided into two individual system.



### C. Interlock System

2 or more than 2 valves are interlocked connecting in one system and all valves are in service but regenerate individually. The wiring refers to Figure 3-12:

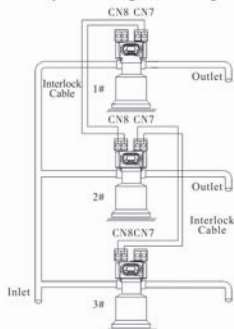

Figure 3-12 Interlock system

### 3.3. System Configuration and Flow Rate Curve

#### A. Product Configuration

1).Product configuration with tank, resin volume, brine tank and injector for F63P/F68P/F65P/F69P softener valve.

Item No.	Tank Size (mm)	Resin Volume (L)	Flow Rate (t/h)	Brine Tank Size (mm)	Minimum Salt Consumption for Regeneration (Kg)	Injector Model (old/new)
1	φ 180 × 1130	16	0.5	φ 250 × 520	2.40	6302/6801
2	φ 205 × 1300	25	0.7	φ 390 × 810	4.00	6303/6802
3	φ 255 × 1390	40	1.2	φ 390 × 810	6.00	6305/6804
4	φ 300 × 1650	60	1.8	φ 450 × 940	9.00	6306/6806
5	φ 355 × 1650	100	2.5	φ 500 × 1060	15.00	6308/6808
6	φ 400 × 1650	120	3.5	φ 550 × 1160	18.00	6309/6809
7	φ 450 × 1650	150	4.5	φ 500 × 1160	22.50	6310/6810

**Note:** The tank size and brine tank configuration should comply with the technical requirements of softener valves.

**Item 1-4** should be selected for the softener valve of 2m<sup>3</sup>/h water treatment capacity.

## MODEL:F63P/F68P/F65P/F69P/F67P/F71P

2) Product configuration with tank, filter material volume for F67P/F71P filter valve.

Item No.	Tank Size (mm)	Filter Material Volume (L)	Carbon Filter		Sand Filter	
			Filtering Flow Rate (m <sup>3</sup> /h)	Backwash Flow Rate (m <sup>3</sup> /h)	Filtering Flow Rate (m <sup>3</sup> /h)	Backwash Flow Rate (m <sup>3</sup> /h)
1	φ 180 × 1130	16	0.3	0.9	0.6	1.3
2	φ 205 × 1300	25	0.4	1.1	0.8	1.7
3	φ 255 × 1390	40	0.6	1.7	1.2	2.6
4	φ 300 × 1650	60	0.8	2.5	1.7	3.8
5	φ 355 × 1650	100	1.2	3.4	2.4	5.2
6	φ 400 × 1650	120	1.5	4.5	3.1	6.8

**Note:** The filtering flow rate of carbon filter is calculated based on the 12m/h operation rate; the backwash flow rate is calculated based on the 10L/(m<sup>2</sup>\*s) backwash intensity.

The filtering flow rate of sand filter is calculated based on the 25m/h operation rate; the backwash flow rate is calculated based on the 15L/(m<sup>2</sup>\*s) backwash intensity.

Item 1-3 should be selected for the filter valve of 2m<sup>3</sup>/h water treatment capacity.

### B. Flow Rate Characteristic

#### 1). Pressure-flow rate curve

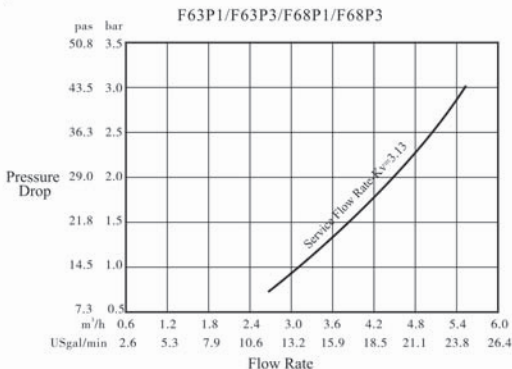

MODEL:F63P/F68P/F65P/F69P/F67P/F71P

F65P1/F65P3/F69P1/F69P3

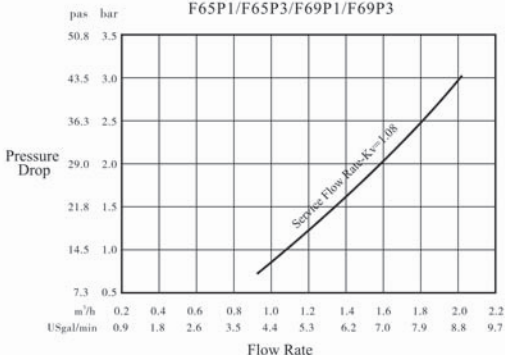

F71P1

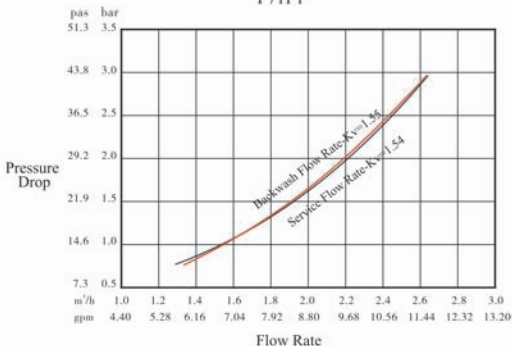

**MODEL:F63P/F68P/F65P/F69P/F67P/F71P**

**F67P1**

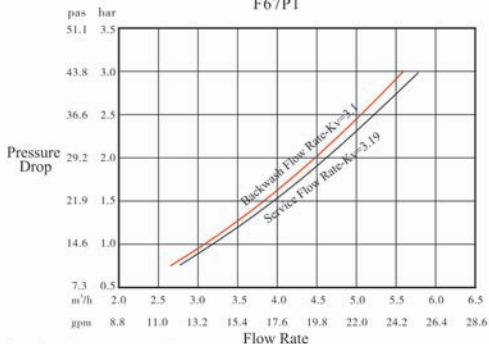

**2) Injector Parameter Table**

Old Injector: (6300 series)

Inlet Pressure	Draw Rate (L/M)									
	6301 Coffee	6302 Pink	6303 Yellow	6304 Blue	6305 White	6306 Black	6307 Purple	6308 Red	6309 Green	6310 Orange
0.15	0.81	1.12	1.58	2.21	2.45	3.30	3.44	4.08	5.19	5.69
0.20	0.95	1.41	1.87	2.53	2.89	3.88	4.21	4.83	5.36	6.80
0.25	0.99	1.61	2.08	2.79	3.30	4.30	4.66	5.39	6.86	7.65
0.30	1.30	1.81	2.18	3.05	3.66	4.74	5.15	5.95	7.50	8.60
0.35	1.45	1.96	2.39	3.27	3.94	5.02	5.55	6.51	8.30	9.57
0.40	1.56	2.12	2.55	3.50	4.25	5.41	5.88	6.77	8.74	9.90

New Injector: (6800 series)

Inlet Pressure	Draw Rate (L/M)											
	6820 Gray	6821 Cyan	6801 Coffee	6802 Pink	6803 Yellow	6804 Blue	6805 White	6806 Black	6807 Purple	6808 Red	6809 Green	6810 Orange
0.15	0.61	0.88	1.30	1.45	2.00	2.68	2.72	3.72	4.52	4.85	5.75	6.00
0.20	0.70	1.03	1.52	1.73	2.37	3.16	3.27	4.27	5.03	5.70	6.40	6.26

## MODEL:F63P/F68P/F65P/F69P/F67P/F71P

0.25	0.79	1.14	1.77	1.90	2.70	3.46	3.78	4.80	5.65	6.22	7.19	7.13
0.30	0.87	1.27	1.93	2.26	3.00	3.80	4.30	5.23	6.20	6.80	7.97	8.53
0.35	0.95	1.35	2.08	2.20	3.23	4.05	4.50	5.57	6.67	7.27	8.50	8.80
0.40	1.00	1.43	2.23	2.27	3.46	4.38	4.88	5.95	6.95	7.63	8.80	9.30

### 3) Configuration for Standard Injector and Drain Line Flow Control

Old Injector: (6300 series)

Item No.	Tank Dia. mm	Injector Model	Injector Color	Draw Rate	Slow Rinse Rate	Brine Refill Rate	DLFC	Backwash/Fast Rinse Rate
				L/m	L/m	L/m		L/m
1	150	6301	Coffee	1.30	0.91	3.00	1#	4.70
2	175	6302	Pink	1.81	1.32	3.70	1#	4.70
3	200	6303	Yellow	2.18	1.73	3.80	2#	8.00
4	225	6304	Blue	3.05	2.14	3.30	2#	8.00
5	250	6305	White	3.66	2.81	4.30	3#	14.40
6	300	6306	Black	4.74	3.32	4.20	3#	14.40
7	325	6307	Purple	5.15	3.55	4.10	4#	22.80
8	350	6308	Red	5.95	4.00	4.00	4#	22.80
9	400	6309	Green	7.50	5.13	4.00	5#	26.40
10	450	6310	Orange	8.60	5.98	3.90	5#	26.40

New Injector: (6800 series)

Item No.	Tank Dia. mm	Injector Model	Injector Color	Draw Rate	Slow Rinse Rate	BLFC Code	Brine Refill Rate	DLFC Code	Backwash/Fast Rinse Rate
				L/m	L/m		L/m		L/m
1	150	6821	Cyan	1.27	0.75	8468057	0.98	8468064	3.33
2	175	6801	Coffee	1.93	1.18	8468057	0.98	8468043	4.31
3	200	6802	Pink	2.26	1.24	8468056	1.21	8468042	7.15
4	225	6803	Yellow	3.00	1.70	8468056	1.21	8468060	7.64
5	250	6804	Blue	3.80	2.40	8468052	1.66	8468061	10.82
6	300	6806	Black	5.23	3.30	8468053	2.73	8468077	18.10
7	325	6807	Purple	6.20	3.73	8468053	2.73	8468044	18.50
8	350	6808	Red	6.80	4.10	8468054	4.92	8468062	24.97

**MODEL:F63P/F68P/F65P/F69P/F67P/F71P**

9	400	6809	Green	7.97	4.87	8468055	5.86	8468063	30.64
10	450	6810	Orange	8.53	5.60	8468055	5.86	NO DLFC	32.00

**4). BLFC Parameter Table (Only for New Injector)**

Part Number	8468076	8468075	8468057	8468056	8468052	8468053	8468054	8468055	
Color	Red	Purple	Black	White	Coffee	Pink	Yellow	Blue	
Flow Rate	L/m	0.38	0.68	0.98	1.21	1.66	2.73	4.92	5.86
	gal/min	0.10	0.18	0.26	0.32	0.44	0.72	1.30	1.55

**5). DLFC Parameter Table (Only for New Injector)**

Part Number	8468064	8468043	8468042	8468060	8468061	8468045	8468077	8468044	8468062	8468063	No DLFC	
Color	Green	Pink	Coffee	White	Black	Blue	Orange	Yellow	Purple	Red	/	
Flow Rate	L/m	3.33	4.31	7.15	7.64	10.82	15.96	18.10	18.50	24.97	30.64	32.00
	gal/min	0.88	1.14	1.89	2.02	2.86	4.22	4.78	4.89	6.60	8.10	8.45

**Note:** Above data for the product configuration and relevant characteristics are only for reference. When put in practice, it is subject to the different requirements of raw water hardness and application.

Item 1-6 should be selected for the softener valve of 2m<sup>3</sup>/h water treatment capacity.

**3.4. Parameter settlement**

①Service Time T1

Water treatment capacity:

$$Q = V_R \times K \div Y_D \quad (m^3)$$

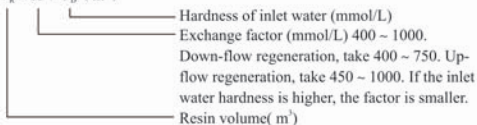

By hours:  $T1 = Q \div Q_h \quad (\text{Hour})$

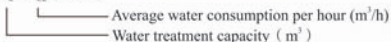

By days:  $T1 = Q \div Q_d \quad (\text{Day})$

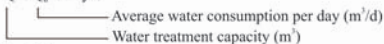

②Backwash Time T2

Generally, it is suggested to be set 10~15 minutes. The higher the turbidity is, the longer

## MODEL:F63P/F68P/F65P/F69P/F67P/F71P

backwash time can be set. However, if the turbidity is more than 5FTU, it should be better to install a filter in front of the exchanger.

### ③Brine& Slow Rinse Time T3

$$T3=(40 \sim 50) \times H_r \text{ ( min. )}$$

$$\text{Generally, } T3=45H_r \text{ ( min. )}$$

In this formula,  $H_r$ —The height of resin in exchange tank (m.)

### ④Brine Refill Time T4

$$\text{Down-flow regeneration: } T4 = 0.45 \times V_r \div \text{Brine refill speed (min.)}$$

$$\text{Up-flow regeneration: } T4 = 0.34 \times V_r \div \text{Brine refill speed (min.)}$$

In this formula,  $V_r$ —Resin volume ( $m^3$ )

The Brine refill speed is related to inlet water pressure. It is suggested to be 1~2 minutes longer than the calculated brine refilling time to make sure there is enough water in tank. (The brine tank should be equipped with liquid level controller)

### ⑤Fast Rinse Time T5

$$T5=12 \times H_r \text{ ( min. )}$$

Generally, the water for fast rinse is 3~6 times of resin volume. It is suggested to be set 10~16 minutes, But it should meet the requirements of qualified outlet water.

### ⑥Exchange Factor

$$\text{Exchange factor} = E / (k \times 1000)$$

In this formula,  $E$ — Resin working exchange capability ( $\text{mol}/m^3$ ) , it is related to the quality of resin. Down-flow regeneration, take 800 ~ 900. Up-flow regeneration, take 900 ~ 1200.

$K$ — Security factor, always take 1.2 ~ 2. It is related to the hardness of inlet water: the higher the hardness is, the bigger the  $K$  is.

### ⑦Set Up Interval Backwash Times ( Only for F68P/F69P )

When the turbidity of raw water is higher, the interval backwash time could be set F-00. That is to say, backwash in each regeneration; when the turbidity is lower, the interval backwash time could be set F-01(or other number value), it is to say that backwash in every two regeneration. Thus, Service→Brine& slow rinse→Brine refill→ Fast rinse→ Service→Backwash →Brine& slow rinse →Brine refill →Fast rinse.









### ⑧Regeneration Time

The whole cycle for regeneration is about two hours. According to the actual situation, please try to set up the regeneration time when you don't need to use water.

The calculation of parameters for each step is only for reference, the actual proper time will be determined after adjusting by water exchanger supplier. This calculation procedure of softener is only for industrial application; it is not suitable for small softener in residential application.

### 3.5. Parameter Enquiry and Setting

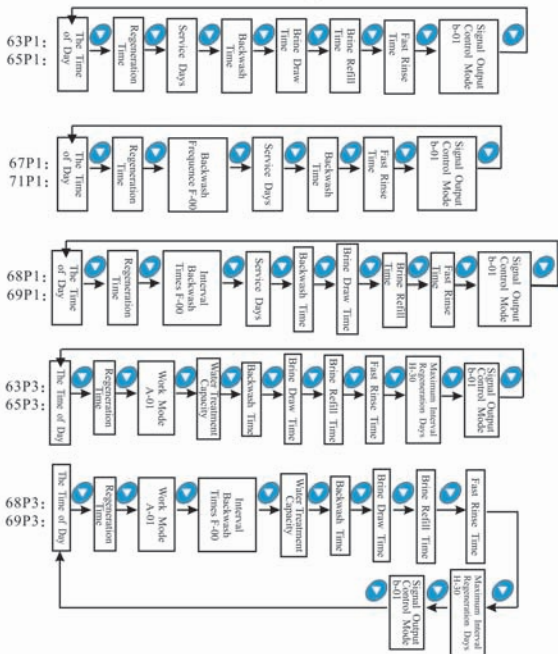

#### 3.5.1. Parameter Enquiry

When  lights on, press and hold both  and  for 5 seconds to unlock the button; then press  and  lights on, enter into program display mode; press  or  to view each value according to below process. (Press  exit and turn back to service status)





















































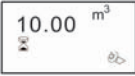

































### 3.5.2.Parameter Setting

In program display mode, press  and enter into program set mode. Press  or  to adjust the value.







### 3.5.3.The steps of parameter setting(Take F63P3, A-01 as sample)

Items	Process steps	Symbol
Time of Day	<p>When time of day "12:12" continuously flash, it reminds to reset;</p> <p>1. Press  to enter into program display mode; both  and  symbol light on, ":" flashes; Press , to set "time of day" mode, both  and hour value flash, through  or  to adjust the hour value;</p> <p>2. Press  again, both  and minute value flash, through  or  to adjust the minute value;</p> <p>3. Press  and hear a sound "Di", then finish adjustment, press  to turn back.</p>	
Regeneration Time	<p>1. In regeneration time display status, press  and enter into program set mode, shows "02:00",  and 02 flash; Press  or  to adjust the hour value;</p> <p>2. Press  again,  and 00 flash, press  or  to adjust the minute value;</p> <p>3. Press  and hear a sound "Di", then finish adjustment, press  to turn back.</p>	
Control Mode	<p>1. In control mode display status, press  and enter into program set mode,  and 01 value flash;</p> <p>2. Press  or , set the value to be A-01/02 control mode;</p> <p>3. Press  and hear a sound "Di", then finish adjustment, press  to turn back.</p>	
Water Treatment Capacity	<p>1. In water treatment capacity display status, it shows  and 10.00. Press  and enter into program set mode.  and 10.00 flash;</p> <p>2. Press  or  to adjust the water treatment capacity integer value (<math>m^3</math>);</p> <p>3. Press  again, both  and 00 flash, through  or  to adjust the water treatment capacity decimal value;</p> <p>4. Press  and hear a sound "Di", then finish adjustment, press  to turn back.</p>	













**MODEL:F63P/F68P/F65P/F69P/F67P/F71P**

<p>Back-wash Time</p>	<p>1. In backwash time display status, it shows  and 2-10. Press  and enter into program set mode.  and 10 flash;</p> <p>2. Press  or  to adjust the backwash time (minute);</p> <p>3. Press  and hear a sound "Di", then finish adjustment, press  to turn back.</p>	
<p>Brine&amp; Slow Rinse Time</p>	<p>1. In brine&amp; slow rinse time display status, it shows  and 3-60. Press  and enter into program set mode.  and 60 flash;</p> <p>2. Press  or  to adjust the brine &amp; slow rinse time (minute);</p> <p>3. Press  and hear a sound "Di", then finish adjustment, press  to turn back.</p>	
<p>Brine Refill Time</p>	<p>1. In brine refill time display status, it shows  and 4-05, Press  and enter into program set mode.  and 05 flash;</p> <p>2. Press  or  to adjust the brine refill time (minute);</p> <p>3. Press  and hear a sound "Di", then finish adjustment, press  to turn back.</p>	
<p>Fast Rinse Time</p>	<p>1. In fast rinse time display status, it shows  and 5-10. Press  and enter into program set mode.  and 10 flash;</p> <p>2. Press  or  to adjust the fast rinse time (minute);</p> <p>3. Press  and hear a sound "Di", then finish adjustment, press  to turn back.</p>	
<p>Maximum Interval Regeneration Days</p>	<p>1. In maximum interval regeneration days display status, it shows H-30. Press  and enter into program set mode.  and 30 flash;</p> <p>2. Press  or  to adjust the interval regeneration days (Day);</p> <p>3. Press  and hear a sound "Di", then finish adjustment, press  to turn back.</p>	

## MODEL:F63P/F68P/F65P/F69P/F67P/F71P





Signal Output Mode	<ol style="list-style-type: none"><li>1. In signal output mode display status, it shows b-01. Press  and enter into program set mode.  and 01 flash;</li><li>2. Press  or  to adjust the output mode ;</li><li>3. Press  and hear a sound "Di", then finish adjustment, press  to turn back.</li></ol>	<div data-bbox="720 189 937 309" style="border: 1px solid black; padding: 10px; text-align: center;">b-01 </div>
--------------------	--	---

For example, the fast rinse time of a softener is 12 minutes. After regenerating, the chloridion in the outlet water is always higher than normal, indicating that there is not enough time for fast rinse. If you want the time to set to 15 minutes, the modification steps as follows:

- ① Press and hold both  and  to unlock the button. (  lights off);
- ② Press , and  lights on;
- ③ Press  or  continuously until  lights on. Then the digital area shows: 5-12M;
- ④ Press ,  and 12 flash;
- ⑤ Press  continuously until 12 changed to 15;
- ⑥ Press , there is a sound "Di" and the figure stop flashing; the program back to program display mode.
- ⑦ If you want to adjust other parameters, you can repeat the steps from ② to ⑤ If you don't, press  and exit from the program display mode, the display will show the current service status.



### 3.6. Trial Running



After installing the multi-functional flow control valve on the resin tank with the connected pipes, as well as setting up the relevant parameters, please conduct the trail running as follows:



- A. Close inlet/outlet valve B and Valve C, open bypass valve A, clean the impurity in the pipe, and then close the bypass valve A. (As Figure 1-3 shows)
- B. Add calculated water to the brine tank and adjust the air check valve. Then add solid salt to the brine tank and dissolve the salt as much as possible.
- C. Switch on power. Press  and enter into the backwash status; when  lights on, slowly open the inlet valve B to 1/4 position, making the water flows into the resin tank; you can hear the sound of air-out from the drain pipeline. After all air is out of pipeline, then open inlet valve B completely and clean the impurity in the resin tank until the outlet water is clean. It will take 8~10 minutes to finish the whole process.
- D. Press , and turn the status from backwash to brine& slow rinse; When  lights on

## MODEL:F63P/F68P/F65P/F69P/F67P/F71P

and enter in the process of brine& slow rinse. The air check valve will close when control valve finished sucking brine, then slow rinse starts to work. It is about 60~65 minutes for whole process.

E. Press  to brine refill status. When  lights on and it indicates the brine tank is being refilled with water to the required level. It takes about 5~6 minutes, then add solid salt to the brine tank.

F. Press , and turn to fast rinse status. When  lights on and starts to fast rinse. After 10~15 minutes, take some outlet water for testing: if the water hardness reaches the requirement, and the content of chloridion in the outlet water is almost same as the inlet water, then the valve can go to the next step.

G. Press , make the control valve return to service status; When  lights on and starts running.

### Note:

● When the control valve enters into the regeneration status, all program can be finished automatically according to the setting time; if you want one of steps to be terminated early, you can press .

● If water inflows is too fast, the media in tank will be damaged. When water inflows slowly, there is a sound of air emptying from drain pipeline.

● After changing the resin, please empty air in the resin according to the above Step C.

● In the process of trial running, please check the water situation in all status, ensuring there are no resin leakage.

● The time for Backwash, Brine& Slow Rinse, Brine Refill and Fast Rinse status can be set and executed according to the calculation in the formula or suggested from the control valve suppliers.

### 3.7. Trouble-Shooting

#### A. Control Valve Fault

Problem	Cause	Correction
1. Softener fails to regenerate.	A. Electrical service has been interrupted. B. Regeneration time set incorrect. C. Controller damaged. D. Motor fails to work.	A. Assure permanent electrical service (Check fuse, plug, switch and so on). B. Reset regeneration time. C. Replace controller. D. Replace motor.
2. Regeneration time is not correct.	A. Time of day does not set correctly. B. Power failure more than 3 days.	A. Check program and reset time of day. B. Reset time of day.

**MODEL:F63P/F68P/F65P/F69P/F67P/F71P**

<p>3. Softener supply hard water.</p>	<p>A. Bypass valve is open or leaking.                  B. No salt in brine tank.                  C. Injector plugged.                  D. Insufficient water flows into brine tank.                  E. O-ring on riser pipe leaks                  F. Internal valve leaks.                  G. Regeneration cycles are not correct or raw water quality deterioration.                  H. Shortage of resin.                  I. Bad quality of feed water or impeller blocked.</p>	<p>A. Close or repair bypass valve.                  B. Make sure there is solid salt in the brine tank.                  C. Change or clean injector.                  D. Check brine tank refill time.                  E. Make sure riser pipe is not cracked. Check o-ring and tube pilot.                  F. Check and repair valve body.                  G. Set correct regeneration time or water capacity.                  H. Add resin to mineral tank and check whether resin leaks.                  I. Reduce the inlet turbidity, clean or replace flow meter.</p>
<p>4. Softener fails to draw brine.</p>	<p>A. Inlet pressure is too low.                  B. Brine line plugged.                  C. Brine line leaks.                  D. Injector plugged or damaged.                  E. Internal control leaks.                  F. Drain line plugged.                  G. Sizes of injector and DLFC are not matched with tank.</p>	<p>A. Increase inlet pressure.                  B. Clean brine line.                  C. Clean brine line.                  D. Clean or replace injector.                  E. Repair or replace valve body.                  F. Clean drain line.                  G. Select correct injector and DLFC according to the instruction requirements.</p>
<p>5. Unit used too much salt.</p>	<p>A. Improper salt setting.                  B. Excessive water in brine tank.</p>	<p>A. Check salt usage and salt setting.                  B. See problem no.6.</p>
<p>6. Excessive water in brine tank.</p>	<p>A. Overlong brine refill time.                  B. Excess water left after brine.                  C. Foreign material in brine valve.                  D. Not install liquid level controller and power failure in brine status.                  E. Brine refill is uncontrolled.</p>	<p>A. Reset correct brine refill time.                  B. Check the injector and make sure no stuff in the brine pipe.                  C. Clean liquid level controller and brine line.                  D. Stop water supplying and restart or install liquid level controller in salt tank when power restored.                  E. Repair or replace liquid level controller.</p>
<p>7. Pressure lost or the pipe rusty.</p>	<p>A. Iron scale in the water supply pipe.                  B. Iron scale accumulated in the softener.                  C. Fouled resin bed.                  D. Too much iron in the raw water.</p>	<p>A. Clean the water supply pipe.                  B. Clean valve and add resin cleaning chemical, increase frequency of regeneration.                  C. Check backwash, brine draw and brine tank refill. Increase frequency of regeneration and backwash time.                  D. Iron removal equipment is required to install before softening.</p>

**MODEL:F63P/F68P/F65P/F69P/F67P/F71P**

8. Resin discharged through drain pipe	A. Air in water system. B. Strainer is broken C. Large drain flow rate when backwash.	A. Empty the air from the system. B. Replace new strainer. C. Check and adjust proper drain rate.
9. Control cycle continuously.	A. Locating signal wire breakdown. B. Controller is faulty. C. Foreign material stuck the driving gear. D. Time of regeneration steps were set to zero.	A. Check and connect locating signal wire. B. Replace controller. C. Take out foreign material. D. Check program setting and reset.
10. Drain flows continuously.	A. Internal valve leaks. B. Power off when in backwash or fast rinse.	A. Check and repair valve body or replace it. B. Adjust valve to service status or turn off bypass valve and restart when electricity supply.
11. Interrupted or irregular brine.	A. Water pressure is too low or not stable. B. Injector is plugged or faulty. C. Air in resin tank. D. Floccules in resin tank during up-flow regeneration.	A. Increase water pressure. B. Clean or replace injector. C. Check and find the reason. D. Clean the floccules in resin tank.
12. Water flows out from drain or brine pipe after regeneration.	A. Foreign material in valve which makes valve can't be closed completely. B. Hard water mixed in valve body. C. Water pressure is too high which results in valve not getting the right status. D. In the backwash status, the outlet line and brine line are connected.	A. Clean foreign material in valve body. B. Change valve core or sealing ring. C. Reduce water pressure or use pressure release function. D. Install a check valve, solenoid valve in front of the outlet or install a liquid level controller in the brine tank.
13. Salt water in outflow pipe	A. Foreign material in injector or injector fails to work. B. Brine valve cannot be shut-off. C. Fast rinse time is too short.	A. Clean and repair injector. B. Repair brine valve and clean it. C. Extend fast rinse time.

**MODEL:F63P/F68P/F65P/F69P/F67P/F71P**

14. Water capacity decreases.	A. Regenerate not properly. B. Fouled resin bed. C. Salt setting is not proper. D. Softener setting is not proper. E. Raw water quality deteriorated. F. Impeller has already gotten stuck.	A. Regenerate according to the right way. B. Increase backwash flow rate and time, clean or change resin. C. Reset the appropriate amount of salt. D. According to the test of outlet water, recount and reset. E. Regenerate by manual temporary, then reset regeneration cycle. F. Disassemble flow meter and clean it or replace it with a new flow meter.
-------------------------------	--	--

**B. Controller Fault**

Problem	Cause	Correction
1. All indicators display on display board	A. Control board damaged. B. Transformer dampened or damaged. C. Electrical service is not stable.	A. Replace control board. B. Check and replace transformer. C. Check and adjust electrical service.
2. No display on display board	A. Wiring of control board and transformer fails to work. B. Control board damaged. C. Transformer damaged D. Electricity is interrupted.	A. Check and replace wiring. B. Replace control board. C. Replace transformer. D. Check electricity supply.
3. E1 Flashes	A. Wiring of locating board and control board damaged. B. Locating board damaged. C. Motor gear and big gear damaged. D. Control board damaged. E. Wiring of motor and control board damaged. F. Motor damaged. G. The set model does not match with the valve body.	A. Replace wiring. B. Replace locating board. C. Replace the motor gear and big gear. D. Replace control board. E. Replace the wiring of motor and control board. F. Replace motor. G. Reconnect to power, and reset the model.
4. E3 or E4 Flashes	A. Control board damaged.	A. Replace control board.

MODEL:F63P/F68P/F65P/F69P/F67P/F71P

**3.8. Assembly & Parts**

Flow Meter Connector & Animated Connector

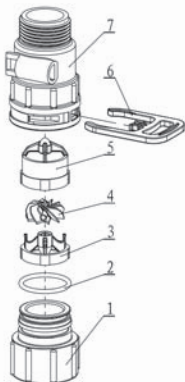

5447018 Flow Meter

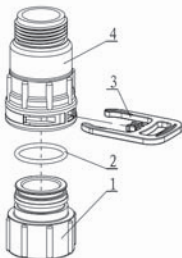

5457002 Animated Connector

5447018 Flow Meter				5457002 Animated Connector			
Item No.	Description	Part No.	Quantity	Item No.	Description	Part No.	Quantity
1	Animated Nut	8945001	1	1	Animated Nut	8945001	1
2	O-ring	8378081	1	2	O-ring	8378081	1
3	Impeller Supporter	5115022	1	3	Clip	8270004	1
4	Impeller	5436010	1	4	Connector	8458038	1
5	Impeller Supporter	5115021	1				
6	Clip	8270004	1				
7	Shell	8002001	1				



MODEL:F63P/F68P/F65P/F69P/F67P/F71P

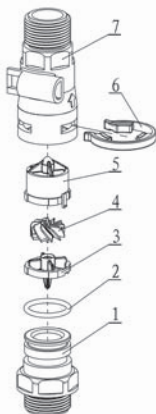

5447020 Flow Meter

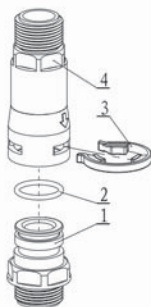

5457003 Animated Connector

5447020 Flow Meter				5457003 Animated Connector			
Item No.	Description	Part No.	Quantity	Item No.	Description	Part No.	Quantity
1	Animated Nut	8458014	1	1	Animated Nut	8458014	1
2	O-ring	8378064	1	2	O-ring	8378064	1
3	Impeller Supporter	5115023	1	3	Clip	8270005	1
4	Impeller	5436013	1	4	Connector	8458039	1
5	Impeller Supporter	5115024	1				
6	Clip	8270005	1				
7	Shell	8002006	1				

MODEL:F63P/F68P/F65P/F69P/F67P/F71P

F63P3 and F68P3 Valve Body Assembly

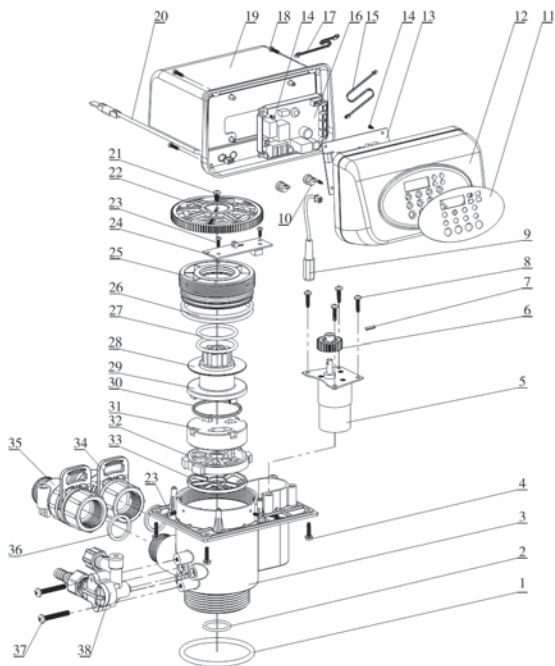

**MODEL:F63P/F68P/F65P/F69P/F67P/F71P**

**F63P1/F63P3 Valve Body Components (Item No. 20, 34, 35 only for F63P3)**

Item No.	Description	Part No.	Quantity
1	O-ring 73×5.3	8378143	1
2	O-ring 25.8×2.65	8378078	1
3	Valve Body (ABS+GF10)	5022033	1
	Valve Body (PPO+GF20)	5022034	
4	Screw, Cross ST3.9×X16	8909016	4
5	Motor	6158011	1
6	Small Gear, Motor	8241003	1
7	Pin	8993003	1
8	Screw, Cross ST3.9×16	8909044	4
9	Wire for Power	5513001	1
10	Cable Clip	8126004	2
11	Label	8865057	1
12	Front Cover	8300038	1
13	Display Board	6381027	1
14	Screw, Cross ST2.2×6.5	8909004	4
15	Wire for Display Board	5512001	1
16	Control Board	6382075	1
17	Wire for Locating Board	5511021	1
18	Screw, Cross ST2.9×16	8909010	4
19	Dust Cover	8005006	1

Item No.	Description	Part No.	Quantity
20	Probe Wire	6386014	1
21	Screw, Cross ST3.9×13	8909013	1
22	Big Gear, Driven	5241033	1
23	Locating Board	6380032	1
24	Screw, Cross ST2.9×9.5	8909008	5
25	Fitting Nut	8092004	1
26	O-ring 73×3.55	8378128	2
27	O-ring 37.7×3.55	8378184	2
28	Anti-friction Washer	8216004	1
29	Shaft	8258004	1
30	Moving Seal Ring	8370001	1
31	Moving Disk	8459001	1
32	Fixed Disk	8469001	1
33	Seal Ring	8370002	1
34	Animated Connector	5457002	1
35	Flow Meter	5447018	1
36	Seal Ring	8371001	2
37	Screw, Cross M5×35	8902017	2
38	Old Injector (6300)	5468009	1
	New Injector (6800)	5468115	

**MODEL:F63P/F68P/F65P/F69P/F67P/F71P**

**F68P1/F68P3 Valve Body Components (Item No. 20, 34, 35 only for F68P3)**

Item No.	Description	Part No.	Quantity	Item No.	Description	Part No.	Quantity
1	O-ring 73×5.3	8378143	1	20	Probe Wire	6386014	1
2	O-ring25.8×2.65	8378078	1	21	Screw, Cross ST3.9×13	8909013	1
3	Valve Body (ABS+GF10)	5022022	1	22	Big Gear, Driven	5241035	1
	Valve Body (PPO+GF20)	5022023		23	Locating Board	6380032	1
4	Screw, Cross ST3.9×X16	8909016	4	24	Screw, Cross ST2.9×9.5	8909008	5
5	Motor	6158011	1	25	Fitting Nut	8092004	1
6	Small Gear, Motor	8241003	1	26	O-ring 73×3.55	8378128	2
7	Pin	8993003	1	27	O-ring 37.7×3.55	8378184	2
8	Screw, Cross ST3.9×16	8909044	4	28	Anti-friction Washer	8216004	1
9	Wire for Power	5513001	1	29	Shaft	8258004	1
10	Cable Clip	8126004	2	30	Moving Seal Ring	8370001	1
11	Label	8865057	1	31	Moving Disk	8459015	1
12	Front Cover	8300038	1	32	Fixed Disk	8469014	1
13	Display Board	6381027	1	33	Seal Ring	8370029	1
14	Screw, Cross ST2.2×6.5	8909004	4	34	Animated Connector	5457002	1
15	Wire for Display Board	5512001	1	35	Flow Meter	5447018	1
16	Control Board	6382075	1	36	Seal Ring	8371001	2
17	Wire for Locating Board	5511021	1	37	Screw, Cross M5×35	8902017	2
18	Screw, Cross ST2.9×16	8909010	4	38	Old Injector (6300)	5468009	1
19	Dust Cover	8005006	1		New Injector (6800)	5468115	

MODEL:F63P/F68P/F65P/F69P/F67P/F71P

**F65P3 and F69P3 Valve Body Assembly**

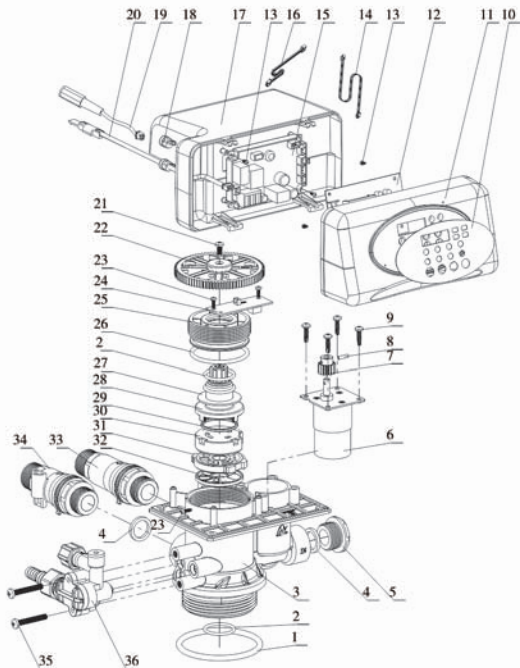

MODEL:F63P/F68P/F65P/F69P/F67P/F71P

## F65P1/F65P3 Valve Body Components (Item No.20, 33, 34 only for F65P3)

Item No.	Description	Part No.	Quantity	Item No.	Description	Part No.	Quantity
1	O-ring 73×5.3	8378143	1	20	Probe Wire	6386014	1
2	O-ring 25.8×2.65	8378078	1	21	Screw, Cross ST3.9×13	8909013	1
3	Valve Body (ABS+GF10)	5022018	1	22	Big Gear, Driven	5241036	1
	Valve Body (PPO+GF20)	5022019		23	Screw, Cross ST2.9×9.5	8909008	5
4	Seal Ring	8371019	3	24	Locating Board	6380033	1
5	Plug	8323005	1	25	Fitting Nut	8092007	1
6	Motor	6158006	1	26	O-ring 50.39×3.53	8378107	1
7	Small Gear, Motor	8241010	1	27	Anti-friction Washer	8216010	1
8	Pin	8993003	1	28	Shaft	8258009	1
9	Screw, Cross ST3.9×16	8909044	4	29	Moving Seal Ring	8370053	1
10	Label	8865057	1	30	Moving Disk	8459013	1
11	Front Cover	8300039	1	31	Fixed Disk	8469012	1
12	Display Board	6381027	1	32	Seal Ring	8370025	1
13	Screw, Cross ST2.2×6.5	8909004	4	33	Animated Connector	5457003	1
14	Wire for Display Board	5512001	1	34	Flow Meter	5447020	1
15	Control Board	6382075	1	35	Screw, Cross M5×35	8902017	2
16	Wire for Locating Board	5511021	1	36	Old Injector(6300)	5468005	1
17	Dust Cover	8005005	1		New Injector(6800)	5468111	
18	Cable Clip	8126004	2				
19	Wire for Power	5513001	1				

**MODEL:F63P/F68P/F65P/F69P/F67P/F71P**

**F69P1/F69P3 Valve Body Components (Item No. 20, 33, 34 only for F69P3)**

Item No.	Description	Part No.	Quantity	Item No.	Description	Part No.	Quantity
1	O-ring 73×5.3	8378143	1	20	Probe Wire	6386014	1
2	O-ring25.8×2.65	8378078	1	21	Screw, Cross ST3.9×13	8909013	1
3	Valve Body (ABS+GF10)	5022024	1	22	Big Gear, Driven	5241036	1
	Valve Body (PPO+GF20)	5022025		23	Screw, Cross ST2.9×9.5	8909008	5
4	Seal Ring	8371019	3	24	Locating Board	6380033	1
5	Plug	8323005	1	25	Fitting Nut	8092007	1
6	Motor	6158006	1	26	O-ring 50.39×3.53	8378107	1
7	Small Gear, Motor	8241010	1	27	Anti-friction Washer	8216010	1
8	Pin	8993003	1	28	Shaft	8258009	1
9	Screw, Cross ST3.9×16	8909044	4	29	Moving Seal Ring	8370053	1
10	Label	8865057	1	30	Moving Disk	8459016	1
11	Front Cover	8300039	1	31	Fixed Disk	8469015	1
12	Display Board	6381027	1	32	Seal Ring	8370034	1
13	Screw, Cross ST2.2×6.5	8909004	4	33	Animated Connector	5457003	1
14	Wire for Display Board	5512001	1	34	Flow Meter	5447020	1
15	Control Board	6382075	1	35	Screw, Cross M5×35	8902017	2
16	Wire for Locating Board	5511021	1	36	Old Injector(6300)	5468005	1
17	Dust Cover	8005005	1		New Injector(6800)	5468111	
18	Cable Clip	8126004	2				
19	Wire for Power	5513001	1				

MODEL:F63P/F68P/F65P/F69P/F67P/F71P

**F71P1 Valve Body Assembly**

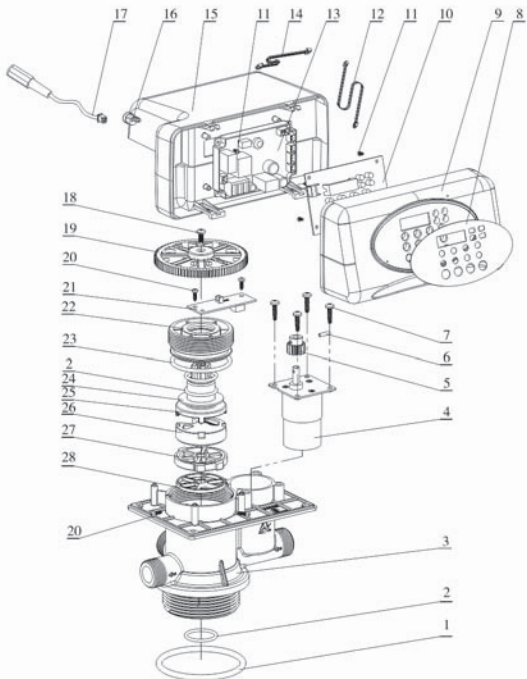



MODEL:F63P/F68P/F65P/F69P/F67P/F71P

F71P1 Valve Body Components

Item No.	Description	Part No.	Quantity	Item No.	Description	Part No.	Quantity
1	O-ring 73 × 5.3	8378143	1	15	Dust Cover	8005005	1
2	O-ring 25.8 × 2.65	8378078	3	16	Cable Clip	8126004	1
3	Valve Body (ABS+GF10)	5022160	1	17	Wire for Power	5513001	1
	Valve Body (PPO+GF20)	5022161		18	Screw, Cross ST3.9×13	8909013	1
4	Motor	6158006	1	19	Big Gear, Driven	8241038	1
5	Small Gear, Motor	8241010	1	20	Screw, Cross ST2.9×9.5	8909008	5
6	Pin	8993003	1	21	Locating Board	6380033	1
7	Screw, Cross ST3.9 × 16	8909044	4	22	Fitting Nut	8092007	1
8	Label	8865057	1	23	O-ring 50.39×3.53	8378107	1
9	Front Cover	8300039	1	24	Anti-friction Washer	8216010	1
10	Display Board	6381027	1	25	Shaft	8258009	1
11	Screw, Cross ST2.2 × 6.5	8909004	4	26	Moving Disk	8459019	1
12	Wire for Display Board	5512001	1	27	Fixed Disk	8469018	1
13	Control Board	6382075	1	28	Seal Ring	8370038	1
14	Wire for Locating Board	5511021	1				

MODEL:F63P/F68P/F65P/F69P/F67P/F71P

F67P1 Valve Body Assembly

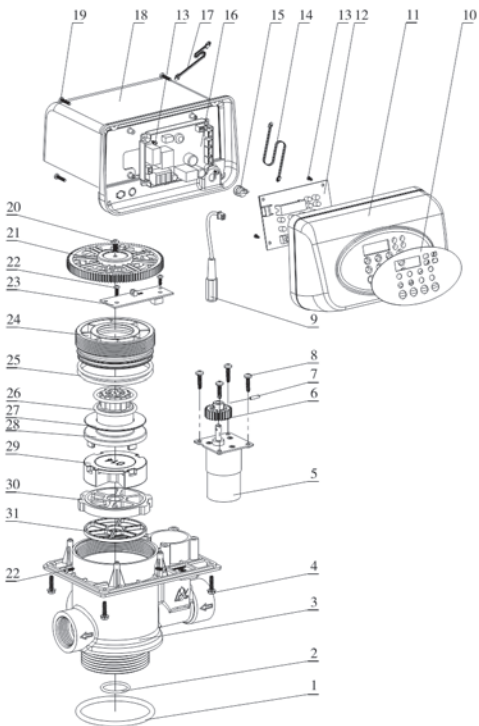

MODEL:F63P/F68P/F65P/F69P/F67P/F71P

## F67P1 Valve Body Components

Item No.	Description	Part No.	Quantity	Item No.	Description	Part No.	Quantity
1	O-ring 73×5.3	8378143	1	16	Control Board	6382075	1
2	O-ring 25.8×2.65	8378078	1	17	Wire for Locating Board	5511021	1
3	Valve Body (ABS+GF10)	5022162	1	18	Dust Cover	8005006	1
	Valve Body (PPO+GF20)	5022163		19	Screw, Cross ST2.9×16	8909010	4
4	Screw, Cross ST3.9×16	8909016	4	20	Screw, Cross ST3.9×13	8909013	1
5	Motor	6158021	1	21	Big Gear, Driven	8241034	1
6	Small Gear, Motor	8241003	1	22	Screw, Cross ST2.9×9.5	8909008	5
7	Pin	8993003	1	23	Locating Board	6380032	1
8	Screw, Cross ST3.9×16	8909044	4	24	Fitting Nut	8092004	1
9	Wire for Power	5513001	1	25	O-ring 73×3.55	8378128	2
10	Label	8865057	1	26	O-ring 37.7×3.55	8378184	2
11	Front Cover	8300038	1	27	Anti-friction Washer	8216004	1
12	Display Board	6381027	1	28	Shaft	8258004	1
13	Screw, Cross ST2.2×6.5	8909004	4	29	Moving Disk	8459014	1
14	Wire for Display Board	5512001	1	30	Fixed Disk	8469013	1
15	Cable Clip	8126004	1	31	Seal Ring	8370027	1

## MODEL:F63P/F68P/F65P/F69P/F67P/F71P

### Structure Chart of New Injector:

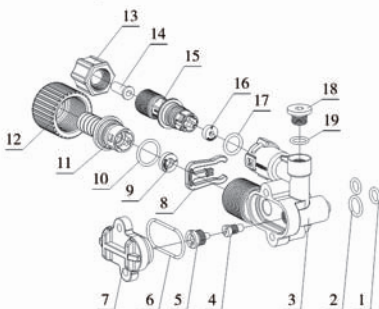

### New Injector (6800 series) Components:

Item No.	Description	Part No.	Quantity	Item No.	Description	Part No.	Quantity
1	O-ring 7.5×1.8	8378016	2	10	O-ring 15×1.8	8378179	1
2	O-ring 10.82×1.78	8378012	1	11	Connector	8458064	1
3	Injector Body	8008010	1	12	Animated Nut	8945025	1
4	Throat (F63P3/F68P3)	8467009	1	13	Nut Nex. Hd	8940001	1
	Throat (F65P3/F69P3)	8467004		14	Tube	8457004	1
5	Nozzle (F63P3/F68P3)	8454009	1	15	Connector	8458068	1
	Nozzle (F65P3/F69P3)	8454004		16	BLFC (F63P3/F68P3)	8468055	1
6	O-ring 30×1.8	8378025	1		BLFC (F65P3/F69P3)	8468052	
7	Injector Cover	8315001	1	17	O-ring 11×2	8378169	1
8	Clip	8270010	1	18	Plug	8323002	1
9	DLFC (F63P3/F68P3)	NO DLFC	1	19	Seal Ring	8370003	1
	DLFC (F65P3/F69P3)	8468061					

## MODEL:F63P/F68P/F65P/F69P/F67P/F71P

### Structure Chart of Old Injector:

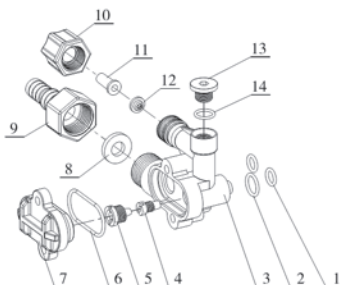

### Old Injector (6300 series) Components:

Item No.	Description	Part No.	Quantity	Item No.	Description	Part No.	Quantity
1	O-ring 7.5×1.8	8378016	2	8	DLFC (F63P3/F68P3)	8468007	1
2	O-ring 10.82×1.78	8378012	1		DLFC (F65P3/F69P3)	8468005	
3	Injector Body	8008001	1	9	Connector	8458017	1
4	Throat (F63P3/F68P3)	8467009	1	10	Nut Nex. Hd	8940001	1
	Throat (F65P3/F69P3)	8467005		11	Tube	8457004	1
5	Nozzle (F63P3/F68P3)	8454009	1	12	BLFC (F63P3/F68P3)	8468002	1
	Nozzle (F65P3/F69P3)	8454005			BLFC (F65P3/F69P3)		
6	O-ring 30×1.8	8378025	1	13	Plug	8323002	1
7	Injector Cover	8315001	1	14	Seal Ring	8370003	1

## 4. Warranty Card

Dear client:

This warranty card is the guarantee proof of Runxin brand multi-functional flow control valve. It is kept by client self. You could get the after-sales services from the supplier which is appointed by Runxin manufacturer. Please keep it properly. It couldn't be retrieved if lost.

It couldn't be repaired free of charge under the below conditions:

1. Guarantee period expired.(One year);
2. Damage resulting from using, maintenance, and keeping that are not in accordance with the instruction.
3. Damage resulting from repairing not by the appointed maintenance personnel.
4. Content in guarantee proof is unconfirmed with the label on the real good or be altered.
5. Damage resulting from force majeure.

Product Name	 Multi-functional Flow Control Valve for Water Treatment Systems	
Model	Code of Valve Body	
Purchase Company Name	Tel/Cel.	
Problem		
Solution		
Date of Repairing	Date of Accomplishment	Maintenance Man Signature

When product needs warranty service, please contact with your direct supplier firstly, after got permission, then fill in the below content and send this card together with the product to the appointed suppliers or Runxin company.

End-user Company Name		Tel/Cel.	
Purchase Company Name		Tel/Cel.	
Model		Code of Valve Body	
Tank Size $\phi$ ×	Resin Volume	L	Raw Water Hardness Mmol/L
Water Source: Ground-water: Tap Water:	Water Treatment Capacity	m <sup>3</sup>	Backwash Time min
Brine & Slow Rinse Time min	Brine Refill Time	min	Fast Rinse Time min
Problem Description			



---

**WENZHOU RUNXIN MANUFACTURING MACHINE CO.,LTD**

ADD: NO.169, RUNXIN ROAD, SHANFU TOWN, WENZHOU, ZHEJIANG, CHINA.

TEL.:0086-577-88630038, 88576512, 85956057      FAX:0086-577-88633258

E-MAIL: [sales@run-xin.com](mailto:sales@run-xin.com)      <http://www.run-xin.com>